

Kaseta Akustyczna

TYP 1

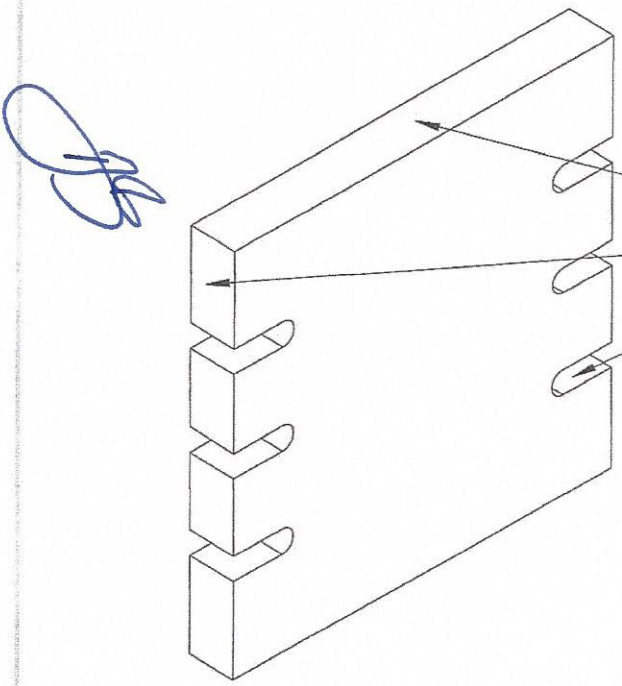

Wymagana ilość: -4szt. scena -3szt. orkiestron		IMIĘ I NAZWISKO	FODPIS	DATA	nr certyfikatu CSWA	07.02.2016	C-GTG47FHAT
Opera Nova w Bydgoszczy		Dokumentacja techniczna					
Kaseta Akustyczna TYP 1		MATERIAŁ: drewno					
WYKONAWCY		NR RYSUNKU		SKALA: 1:5			
ARXUSZ 1 Z 1		A4					



okucie z blachy

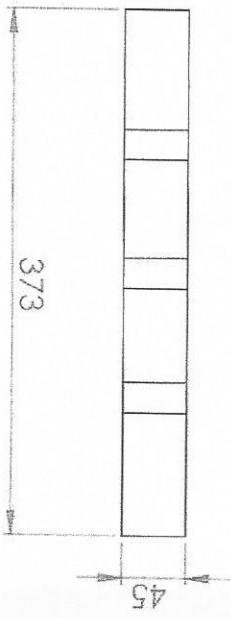
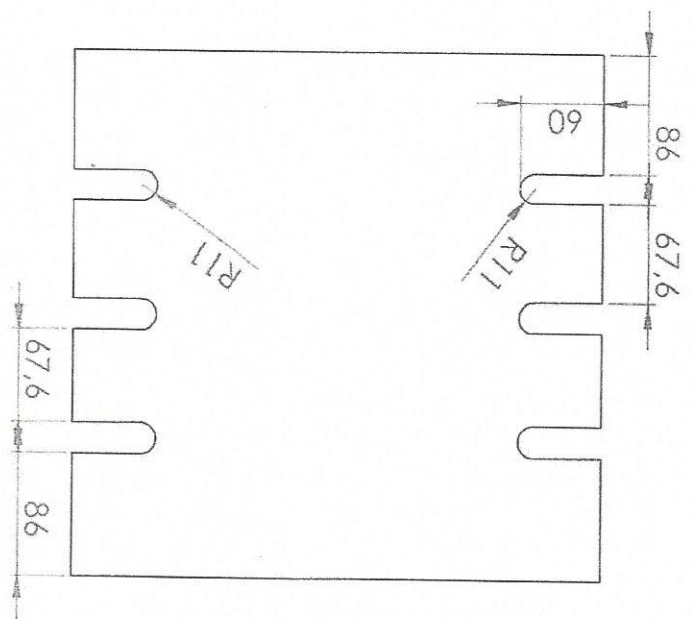
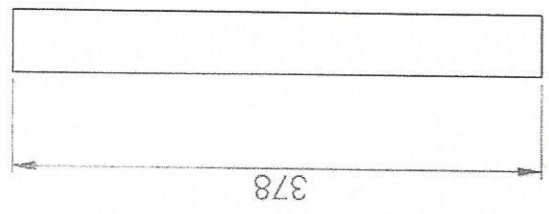

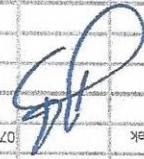
Wymagana ilość: -4szt. scena -3szt. orkiestron		IMIE I NAZWISKO		PODPIS	DATA	nr.certyfikatu CSWA	NARYS	
		Paliński Jacek			07.02.2016	C-01G47FHAT		
Opera Nova w Bydgoszczy		Dokumentacja techniczna		MATERIAL: stal		NR RYSUNKU		SKALA: 1:10
Kaseta Akustyczna TYP 1		WYKONAWCY		ARKUSZ 1 Z 1		A4		

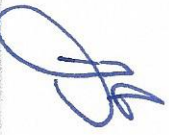

PRZEKRÓJ A-A
SKALA 1 : 4

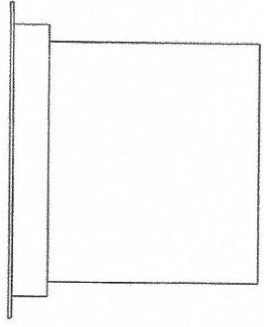
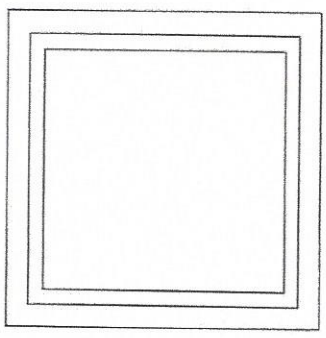
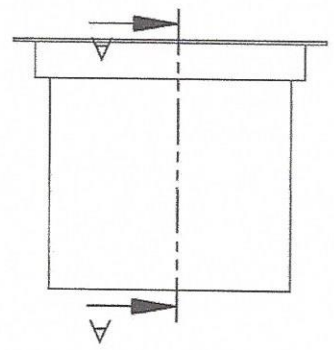
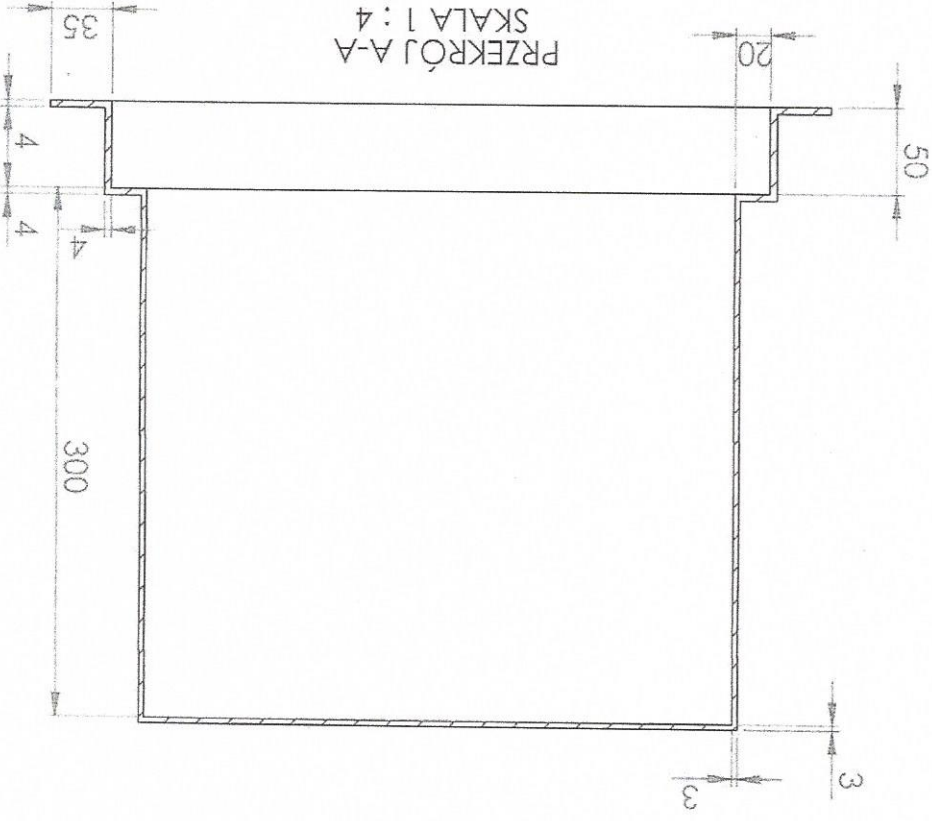

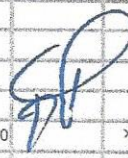
Wymagana ilość: -4szt. scena -3szt. orkiestron		Opera Nova w Bydgoszczy		Dokumentacja techniczna	
IMIE I NAZWISKO	DATA	nr certyfikatu GSWA	DATA	DATA	DATA
Podpis	07.02.2016	C-01G47FHAT			
					
MATERIAŁ: stal		NR RYSUNKU		WYKONAWCY	
				A4	
		SKALA: 1:5		ARKUSZ 1 Z 1	

